

DS103 DISPLAY

User Guide

CYC MOTOR

support@cycmotor.com +952 3690 8938



TABLE OF CONTENTS

DS103 Display User Guide 2

- Product Details..... 2
- Dimensions & Materials..... 2
- Quick Start Guide 3
- Functionalities..... 4
 - Trip Mode..... 6
 - Switch Dashboard 6
 - Assist Levels Select..... 7
 - Dark & Light Themed Dashboard 8
 - Walk Assist 8
- Error Codes 9
- Installation 9
- Compatibility..... 10
- Pin Layout..... 10
- Certification..... 10



DS103 Display User Guide

Product Details

Intelligent LCD display, model: DS103

Firmware: CYCMOTOR LTD specific firmware

Features

- Simple and lightweight, separate installation bracket design
- High brightness, high contrast 3.5 coloured TFT screen
- Clock function (clock is on when the display shutdown)
- Excellent outdoor design with IP65 level waterproof
- Micro USB serial communication port, convenient maintenance services

Dimensions & Materials

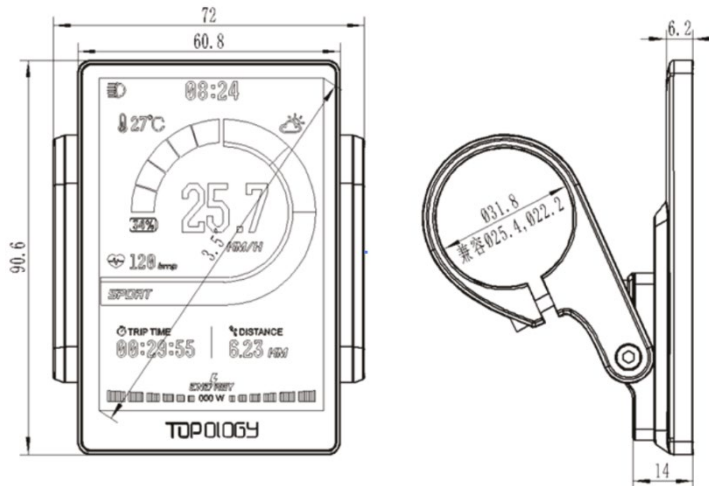

Materials

Product shell – ABS + PC plastic

Transparent window – Tempered glass

Dimensions

L 72mm x W 14mm x H 90.6mm

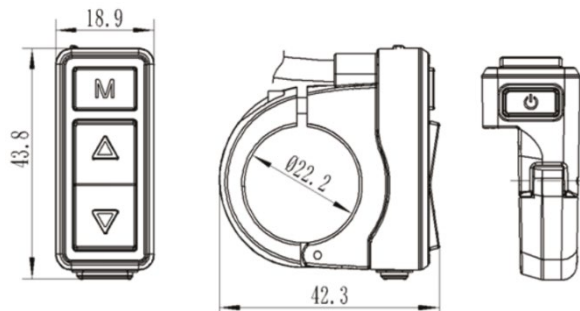



Electrical Specifications

- Power supply: DC 24V/ 36V/ 48V/ 52V
- Rated current: 30ma/36V
- Shutdown leakage current: <1uA
- Screen specification: 3.5” coloured TFT (480*320 pixels)
- Communication method: UART (default)
- Operating temperature: -20°C ~ 60°C
- Storage temperature: -30°C~80°C
- Waterproof level: IP65

Quick Start Guide

After unboxing and installing your CYC motor system, there are two main things you need to set up.

1. Change your Battery No. settings according to your rated voltage.

Upon startup, long press the MENU button within 15 seconds to access the SETTINGS page. Press UP/DOWN to navigate the settings page & MENU to select.

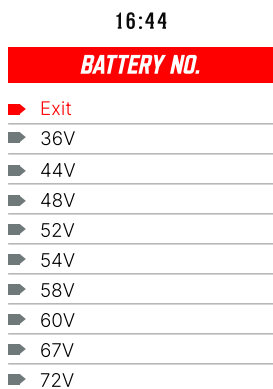

6s = 22.2V	9s = 33.3V	12s = 44.4 V
7s = 25.9V	10s = 36V	13s = 48V
8s = 29.6V	11s = 40.7V	14s = 52V



2. Change your Wheel settings according to your bike’s wheel size.

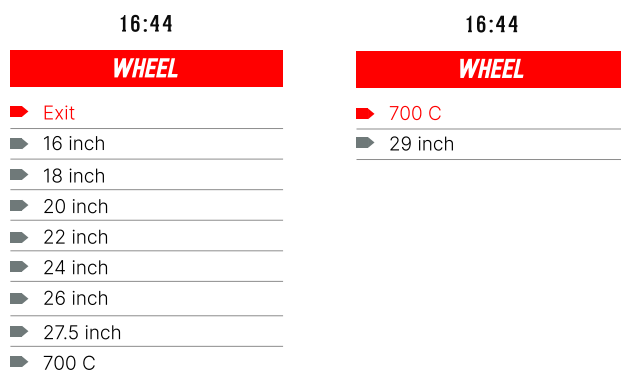

3. You can now set up parameters like temperature and the speed unit as well as the brightness level!

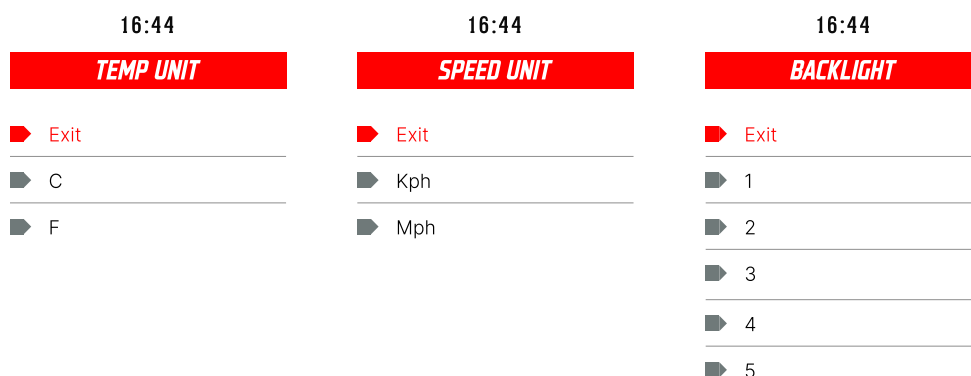

Functionalities

Press and hold the POWER button for 3 seconds to turn the display on/ off.



Navigation

The MENU button is used to go into your main settings page & your clear data page. It is also used to enter and select a setting or function.



Settings

Upon startup, long press the MENU button within 15 seconds to enter the SETTINGS page. Note that once the system is activated for longer than 15 seconds, the motor system will require a restart to enter the settings menu.

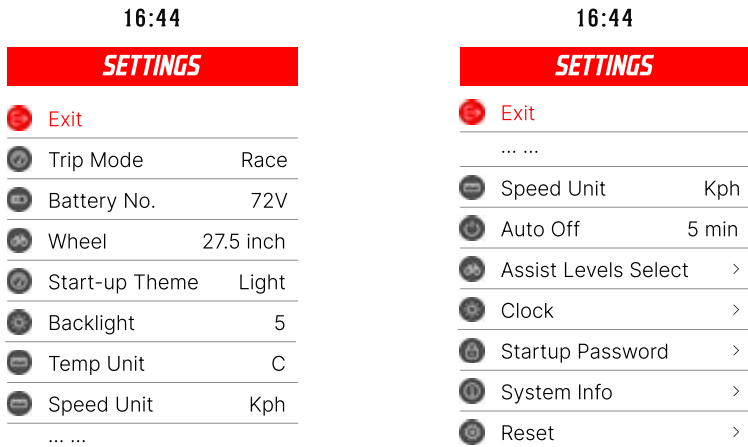

Clean Trip Data

Wait 15 seconds after starting up the motor system to enter the “Clean Data” menu. Long press the MODE button to clear previous trip data. Please note that trip data does not automatically clear once the motor system is restarted. It is a manual process.

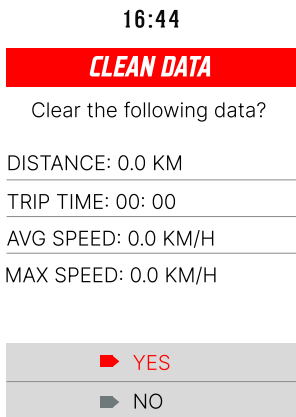



Trip Mode

Upon startup, long press the MENU button within 15 seconds to access the SETTINGS page, then select TRIP MODE to swap between STREET and RACE mode.

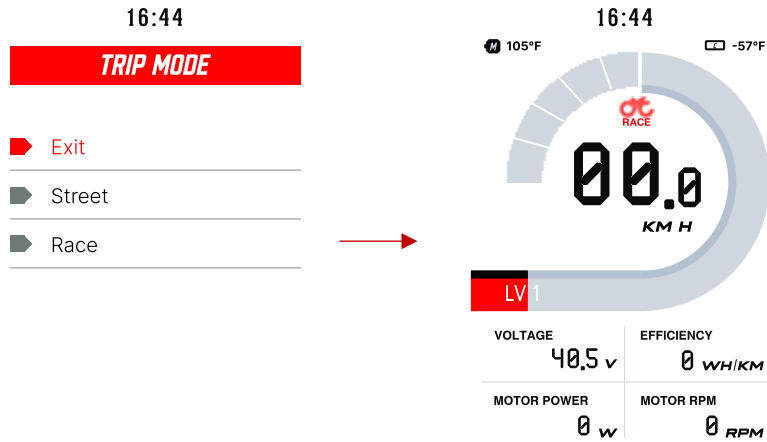

Switch Dashboard

Switch the main dashboard to display different information by pressing the MENU button.

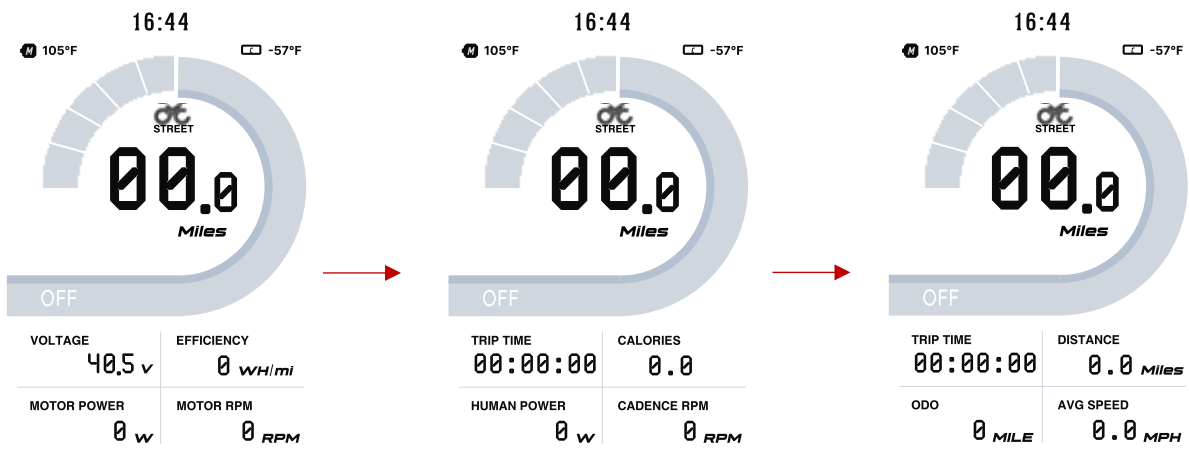



Assist Levels Select

Press the UP/DOWN button to change between assist levels while riding. Note that “OFF” means no motor assistance will be given.

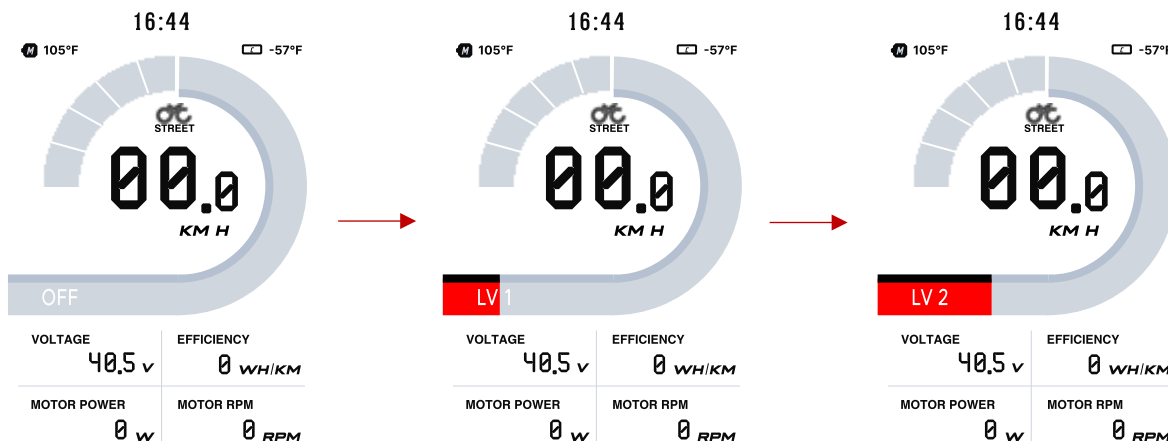

There are 3 sets of assist levels; 3, 5 & 9. To change the assist levels set, long press the MENU button upon within 15 seconds upon startup and access ALL GEAR in the main settings page.

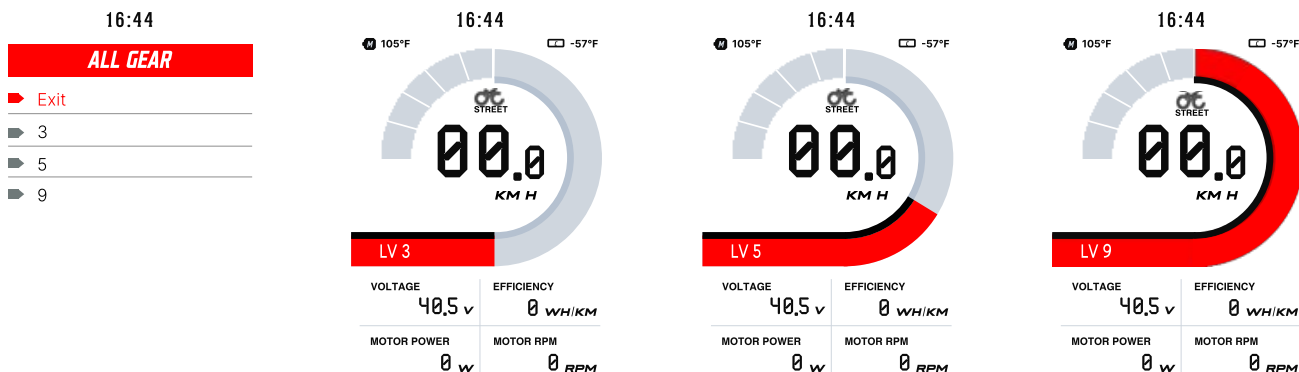



Dark & Light Themed Dashboard

Upon startup, long press the MENU button within 15 seconds to access the SETTINGS page, then select THEME to change between light and dark themed dashboards.

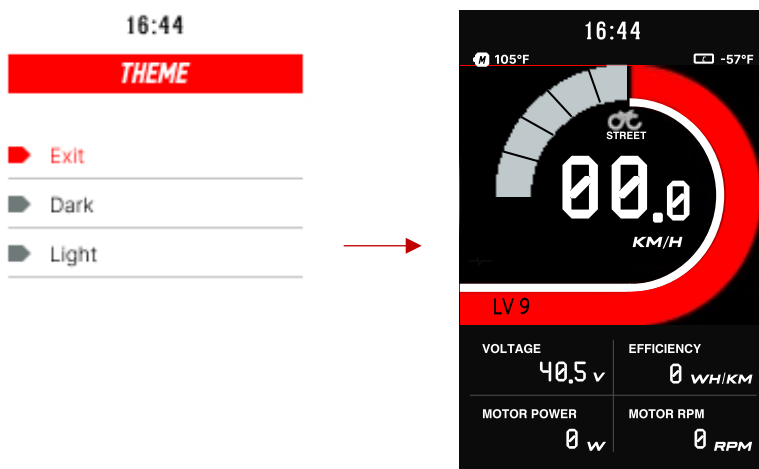

Walk Assist

Hold in the DOWN button to activate walk assist. Please note it takes 3 seconds to activate & will deactivate immediately when the button is released.

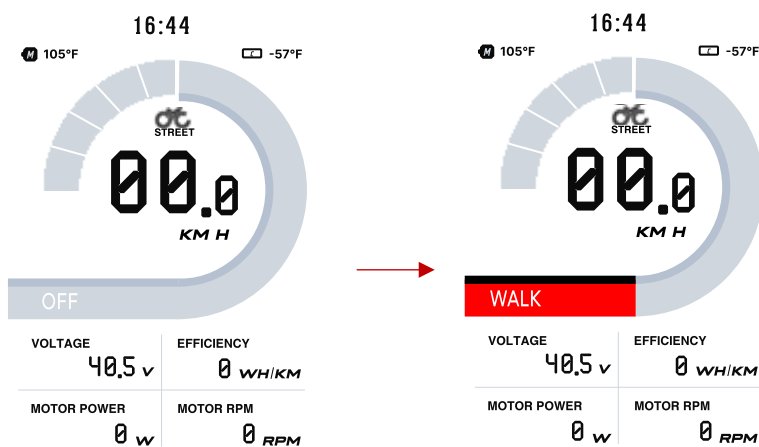



Error Codes

In certain circumstances, an error code may appear on your display. Contact us for assistance.

Error Code on App & DS103 Display
Controller Over Voltage
Controller Under Voltage
Controller Over Temperature
Hall Sensor Error
Throttle Error
Speed Sensor Error
Controller Internal Error 1
Controller Internal Error 2
Controller Internal Error 3
Controller Internal Error 4
Controller Internal Error 5
Controller Internal Error 6
Controller Internal Error 7
Controller Internal Error 8
Controller Internal Error 9
Controller Internal Error 10

Installation

1. Determine if you need to select the corresponding mounting clamp and rubber clip ring according to the diameter of your handlebar (Applicable handlebar specifications: $\Phi 22.2$; $\Phi 25.4$; $\Phi 31.8$).
2. Open the display lock clamp and insert the rubber clip (if applicable) into the correct position of the lock clamp.
3. Set the rubber ring in the bracket (if applicable) then assemble on the middle of the handlebar. You can adjust the angle of the display to make the display screen more visible when riding. After fixing the angle, tighten the screws. The tightening torque is 1N.m.
4. Open lock ring of the switch and set in the appropriate position on the left side of the handlebar. Adjust the angle and position of the switch as needed in order to ensure the switch can be operated easily.
5. Fix and tighten the handlebar fixing screw with the M3 Hex wrench (locking torque is 0.8N.m.)

Note: Damage caused by excessive torque is not covered by warranty.

Compatibility

The clamps are suitable for 3x different handlebar sizes: 31.8mm, 25.4mm & 22.2mm.



Pin Layout

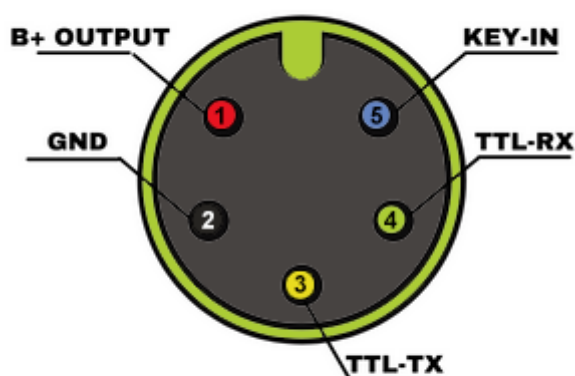

Male 5-Pin Connector

1. **Red Wire:** Anode (36V to 72V)
2. **Black Wire:** GND
3. **Yellow Wire:** TxD (display -> controller)
4. **Green Wire:** RxD (controller -> display)
5. **Blue wire:** Power cord to the controller

Certification

CE / IP65 (waterproof) / ROHS

Be sure to contact us if further assistance is needed. Thank you!